

Deformable Mirror U-Flex-56-HEX-37



- The U-Flex-56-HEX-37 - unimorph deformable Mirror is designed to be applied in medical imaging, laser beam control and shaping, optical communications, and astronomy.
- The Mirror is capable of forming complex surface patterns, the shape of which is computer-controlled and well suited for compensation of low order aberrations (up to 4th order of Zernike).
- The SDK (C++) allows to operate all functions of the mirror and to achieve easy integration with user software.

TECHNICAL SPECIFICATIONS

Aperture diameter	56 mm
Substrate	Glass
Stroke	45 μ m
Initial curvature	25 m
Number of control electrodes	37
Control voltage (max)	\pm 300 V
Resonance frequency	>4000 Hz
Reflecting coatings (optionally)	Al, Ag, Cu, Multilayer Dielectric
Optical Damage threshold in pulsed operation	>0.3 J/cm ²
Surface quality (scratch-dig)	60-40/40-20
Hysteresis	<15 %
Operating temperature	from +10 to +40 °C
Storage temperature	from -30 to +70 °C
Weight	350 g
Size	90x90x32 mm

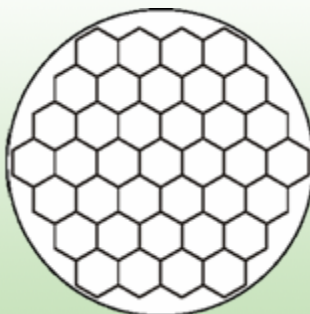

Electrodes arrangement
(view from inner side)

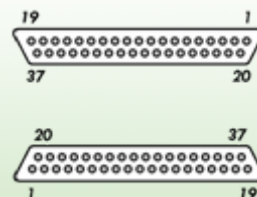

Electrical connector
(2 x 37-pin D-SUB)



VISIONICA

Deformable Mirror U-Flex-56-HEX-37

DIMENSIONS

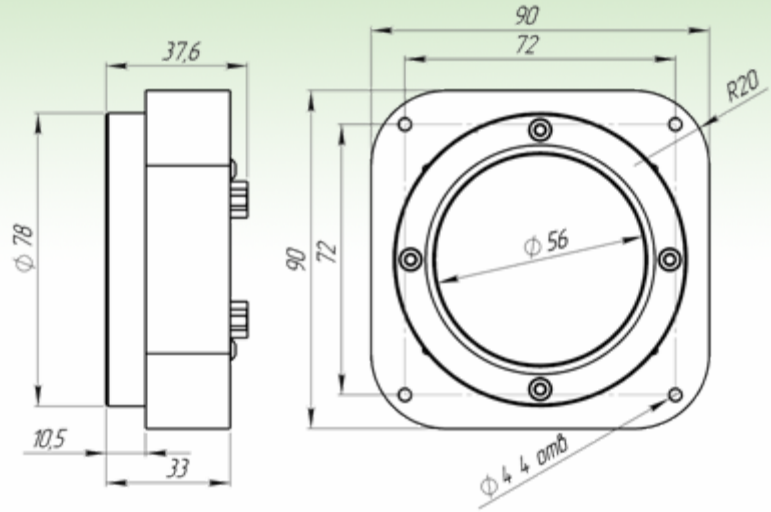

Phone
+7 (499) 213-31-25

WWW
www.visionica.biz

E-mail
visio@optics.ru

Part Number:
VC.DMU-56-G-37-HEX-AL